



# Product Specification

M190EG02 V4

AU OPTRONICS CORPORATION

( ) Preliminary Specification

( V ) Final Specification

<b>Module</b>	19.0" SXGA Color TFT-LCD
<b>Model Name</b>	M190EG02 V4

Customer	Date
_____	_____
<b>Approved by</b>	
_____	_____
Note: This Specification is subject to change without notice.	

Checked & Approved by	Date
<u>CC Chiu</u>	<u>Mar 25, 2007</u>
<b>Prepared by</b>	
<u>Aleg Wu</u>	<u>Mar 25, 2007</u>
Desktop Display Business Group / AU Optronics corporation	

## Contents

<b>1. Handling Precautions</b> .....	<b>4</b>
<b>2. General Description</b> .....	<b>5</b>
2.1 Display Characteristics .....	6
<b>3. Functional Block Diagram</b> .....	<b>11</b>
<b>4. Absolute Maximum Ratings</b> .....	<b>12</b>
4.1 Absolute Ratings of TFT LCD Module.....	12
4.2 Absolute Ratings of Backlight Unit .....	12
4.3 Absolute Ratings of Environment .....	12
<b>5. Electrical characteristics</b> .....	<b>14</b>
5.1 TFT LCD Module .....	14
5.2 Backlight Unit.....	15
<b>6. Signal Characteristic</b> .....	<b>16</b>
6.1 Pixel Format Image.....	16
6.2 The Input Data Format .....	17
6.4 Interface Timing .....	19
6.5 Power ON/OFF Sequence .....	21
<b>7. Connector &amp; Pin Assignment</b> .....	<b>22</b>
7.1 TFT LCD Module .....	22
7.2 Backlight Unit.....	23
<b>8. Reliability Test</b> .....	<b>24</b>
<b>9. Shipping Label</b> .....	<b>25</b>
<b>10. Mechanical Characteristic</b> .....	<b>26</b>

## Record of Revision

Version & Date	Page	Old Description	New Description	Remark
0.1 2006/6/23	All	First Edition for Customer		
0.2 2006/9/7	7	Color / Chromaticity Coordinate	Color/Chromaticity Coordinate update	Updated
	21	Power Sequence Timing T2, T3 = 200ms (min)	Power Sequence Timing T2,T3 = 300ms (min)	Modified
0.3 2006/12/27	6	Weight 2400 (Typ) 2500(Max)	2000(Typ)	Modified
	14	CCFL VCFL Min:--, Typ:653(@7.5mA), Max:796(@3mA)	CCFL VCFL Min:544(@7.5mA) Typ:653(@7.5mA), Max:783(@7.5mA)	Modified
	23	Lamp connector: JST/BHSR-02VS-1/SM02B-1-TB	Lamp connector: CVILUX/CP0502SL090/ CP05T021PE0	Revised
	26-28	10 Mechanical Characteristic	Update new 2D drawing.	Updated
1.0 2007/01/16	All	Final Edition for Customer		Rvised
1.1 2007/03/9	23	Lamp connector: Mating Type Part Number CP05T021PE0	Lamp connector: Mating Type Part Number CP0502P1ML0	Corrected
1.2 2007/04/25	7	Contrast Ratio: Min: 500	Contrast Ratio: Min: 480	Revised
	23	Lamp connector: Manufacturer : CVILUX Type Part Number: CP0502SL090 Mating Type Part Number CP0502P1ML0	Lamp connector: Manufacturer : CVILUX or YEONHO Type Part Number: CP0502SL090/ 35001 HS-02L Mating Type Part Number CP0502P1ML0/ 35001 WR-02L	Revised

## 1. Handling Precautions

- 1) Since front polarizer is easily damaged, pay attention not to scratch it.
- 2) Be sure to turn off power supply when inserting or disconnecting from input connector.
- 3) Wipe off water drop immediately. Long contact with water may cause discoloration or spots.
- 4) When the panel surface is soiled, wipe it with absorbent cotton or other soft cloth.
- 5) Since the panel is made of glass, it may break or crack if dropped or bumped on hard surface.
- 6) Since CMOS LSI is used in this module, take care of static electricity and insure human earth when handling.
- 7) Do not open or modify the Module Assembly.
- 8) Do not press the reflector sheet at the back of the module to any directions.
- 9) In case if a Module has to be put back into the packing container slot after once it was taken out from the container, do not press the center of the Cold Cathode Fluorescent Lamp (CCFL) reflector edge. Instead, press at the far ends of the CCFL reflector edge softly. Otherwise the TFT Module may be damaged.
- 10) At the insertion or removal of the Signal Interface Connector, be sure not to rotate nor tilt the Interface Connector of the TFT Module.
- 11) After installation of the TFT Module into an enclosure, do not twist nor bend the TFT Module even momentary. At designing the enclosure, it should be taken into consideration that no bending/twisting forces are applied to the TFT Module from outside. Otherwise the TFT Module may be damaged.
- 12) Cold Cathode Fluorescent Lamp (CCFL) in LCD contains a small amount of mercury. Please follow local ordinances or regulations for disposal.
- 13) Small amount of materials having no flammability grade is used in the LCD module. The LCD module should be supplied by power complied with requirements of Limited Power Source (IEC60950 or UL1950), or be applied exemption.
- 14) The LCD module is designed so that the CCFL in it is supplied by Limited Current Circuit (IEC60950 or UL1950). Do not connect the CCFL in Hazardous Voltage Circuit.



## 2. General Description

M190EG02 V4 is a Color Active Matrix Liquid Crystal Display composed of a TFT-LCD panel, a driver circuit, and a backlight system. The screen format is intended to support the SXGA (1280(H) x 1024(V)) screen and 16.7M colors (RGB 6-bits + HiFRC data). All input signals are LVDS interface compatible. Inverter card of backlight is not included. M190EG02 V4 is designed for a display unit of personal computer.

## 2.1 Display Characteristics

The following items are characteristics summary on the table under 25 °C condition:

Items	Unit	Specifications
Screen Diagonal	[mm]	482.6 (19.0" )
Active Area	[mm]	376.32 (H) x 301.06 (V)
Pixels H x V		1280(x3) x 1024
Pixel Pitch	[mm]	0.294 (per one triad) x 0.294
Pixel Arrangement		R.G.B. Vertical Stripe
Display Mode		Normally White
White Luminance	[cd/m <sup>2</sup> ]	300 (center, Typ) @ 7.5mA
Contrast Ratio		800 : 1 (Typ)
Optical ResponseTime	[msec]	5 ms(Typ, on/off)
Nominal Input Voltage VDD	[Volt]	+5.0 V
Power Consumption	[Watt]	24.71W (Typ) (PDD=5.11W, PCFL=19.6 W @Lamp=7.5mA)
Weight	[Grams]	2000 (Typ)
Physical Size (H x V x D)	[mm]	396 (H) x 324 (V) x 16.3 (D) (Typ)
Electrical Interface		Dual channel LVDS
Surface Treatment		Hard-coating (3H), Non-Glare treatment
Support Color		16.7M colors (RGB 6-bit data + HiFRC data)
Temperature Range		
Operating	[°C]	0 to +50
Storage (Non-Operating)	[°C]	-20 to +60
RoHS Compliance		RoHS Compliance

## 2.2 Optical Characteristics

The optical characteristics are measured under stable conditions at 25°C (Room Temperature):

Item	Unit	Conditions	Min.	Typ.	Max.	Note
Viewing Angle	[degree]	Horizontal (Right) CR = 10 (Left)	70 70	80 80	-	1
		Vertical (Up) CR = 10 (Down)	70 70	80 80	-	
		Vertical (Up) CR = 5 (Down)	75 75	85 85	-	
		Vertical (Up) CR = 5 (Down)	75 75	85 85	-	
Luminance Uniformity	[%]	9 Points	75	80	-	2, 3
Optical Response Time	[msec]	Rising	-	3.6	5.7	4, 6
		Falling	-	1.4	2.3	
		Rising + Falling	-	5	8	
Color / Chromaticity Coordinates (CIE 1931)		Red x	0.617	0.647	0.677	4
		Red y	0.310	0.340	0.370	
		Green x	0.258	0.288	0.318	
		Green y	0.575	0.605	0.635	
		Blue x	0.115	0.145	0.175	
		Blue y	0.041	0.071	0.101	
		White x	0.283	0.313	0.343	
White y	0.299	0.329	0.359			
White Luminance (At CCFL= 7.5mA)	[cd/m <sup>2</sup> ]		240	300	-	4
Contrast Ratio			480	800	-	4
Cross Talk (At 75Hz)	[%]		-	-	1.5	5
Flicker	[dB]		-	-	-20	7

Optical Equipment: BM-5A, BM-7, PR880, or equivalent

**Note 1: Definition of viewing angle**

Viewing angle is the measurement of contrast ratio  $\geq 10$ , or  $\geq 5$ , at the screen center, over a  $180^\circ$  horizontal and  $180^\circ$  vertical range (off-normal viewing angles). The  $180^\circ$  viewing angle range is broken down as follows;  $90^\circ$  ( $\theta$ ) horizontal left and right and  $90^\circ$  ( $\Phi$ ) vertical, high (up) and low (down). The measurement direction is typically perpendicular to the display surface with the screen rotated about its center to develop the desired measurement viewing angle.

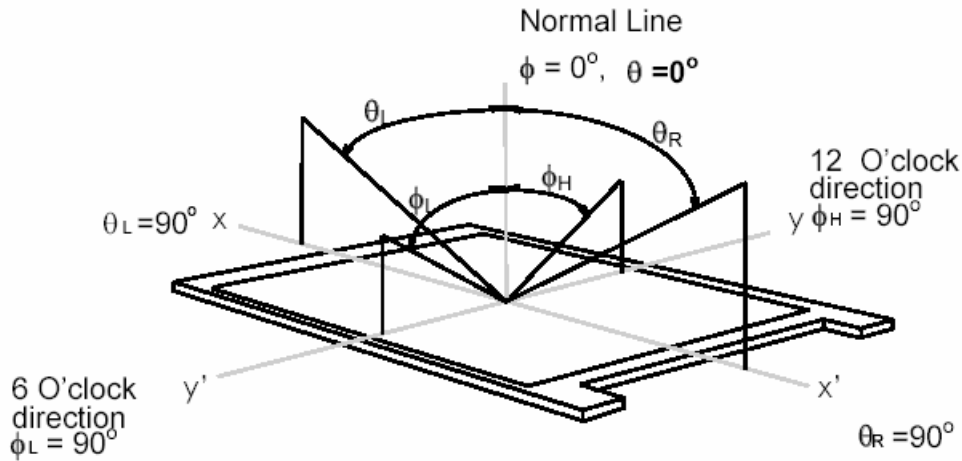

**Note 2: 9 points position**

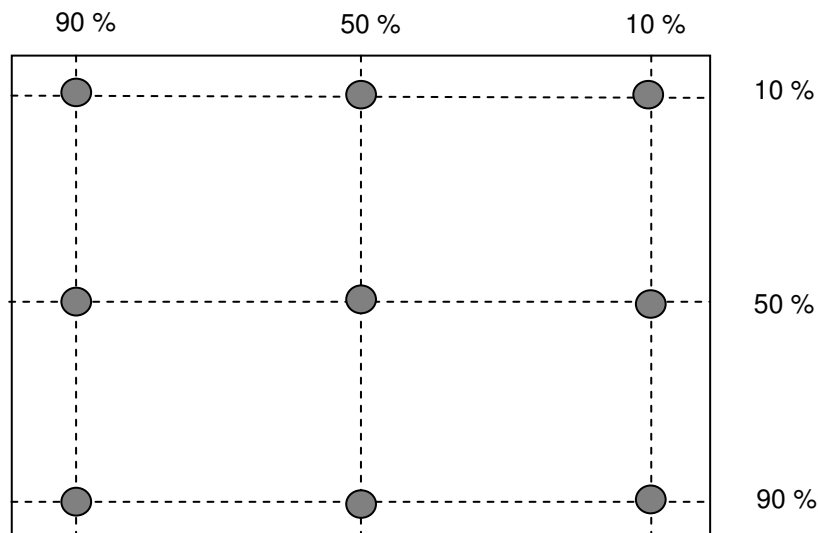

Note 3: The luminance uniformity of 9 points is defined by dividing the maximum luminance values by the minimum test point luminance

$$\delta_{w9} = \frac{\text{Minimum Luminance of 9 points}}{\text{Maximum Luminance of 9 points}}$$



**Note 4: Measurement method**

The LCD module should be stabilized at given temperature for 30 minutes to avoid abrupt temperature change during measuring. In order to stabilize the luminance, the measurement should be executed after lighting Backlight for 30 minutes in a stable, windless and dark room.

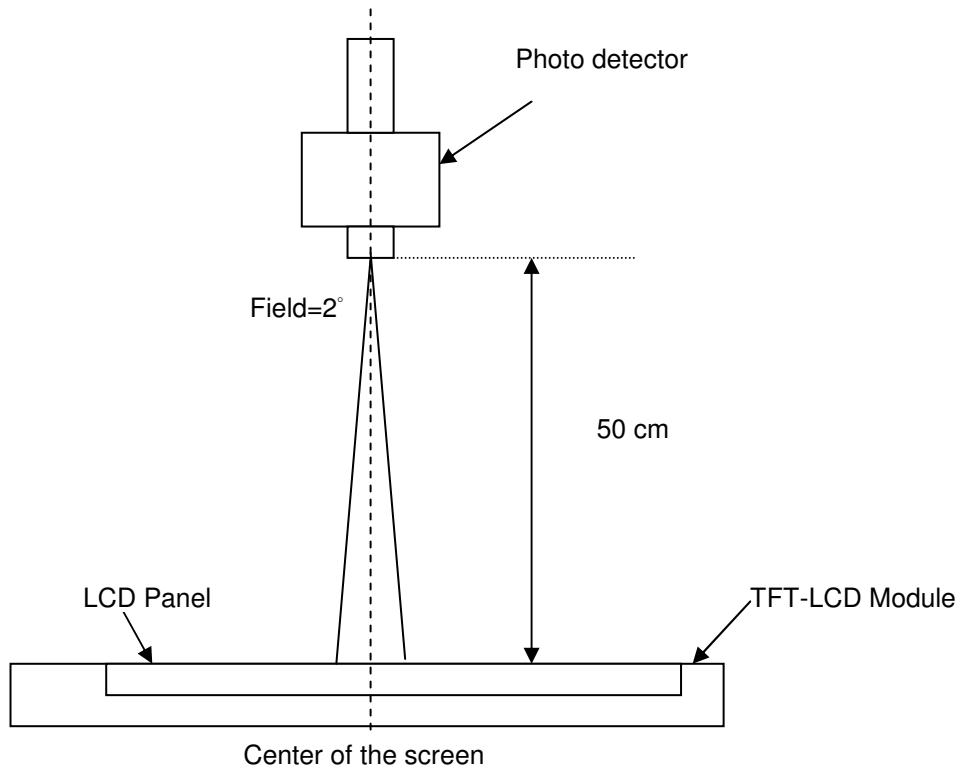

**Note 5: Definition of Cross Talk (CT)**

$$CT = | YB - YA | / YA \times 100 (\%)$$

Where

YA = Luminance of measured location without gray level 0 pattern (cd/m2)

YB = Luminance of measured location with gray level 0 pattern (cd/m2)

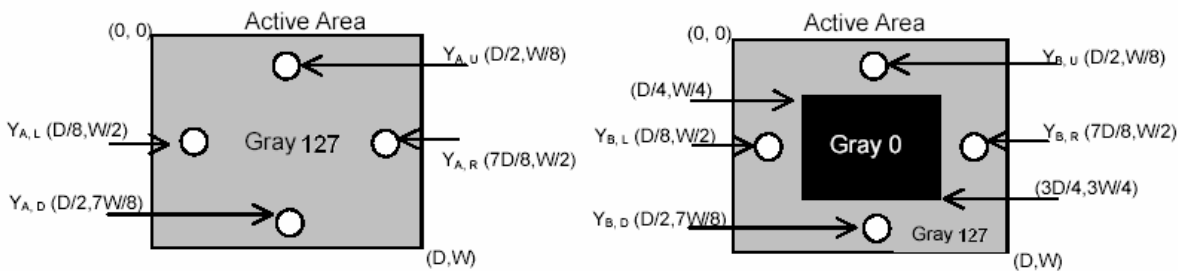

Note 6: Definition of response time:

The output signals of photo detector are measured when the input signals are changed from “Full Black” to “Full White” (rising time), and from “Full White” to “Full Black” (falling time), respectively. The response time is interval between the 10% and 90% of amplitudes. Please refer to the figure as below.

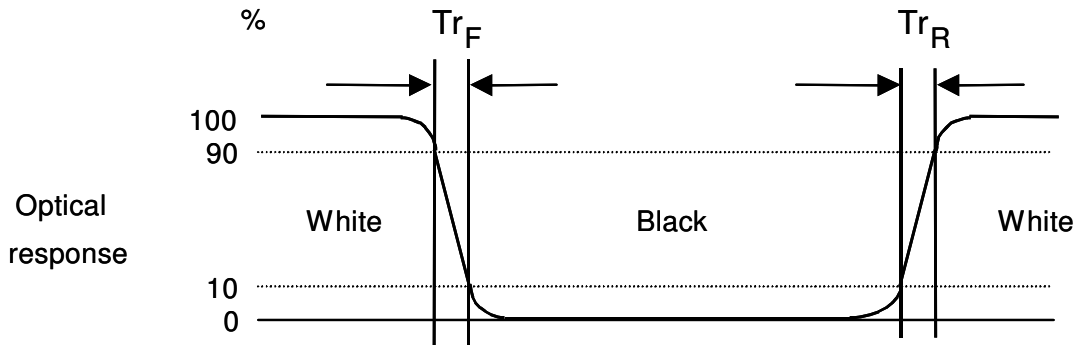

Note 7: Subchecker Pattern

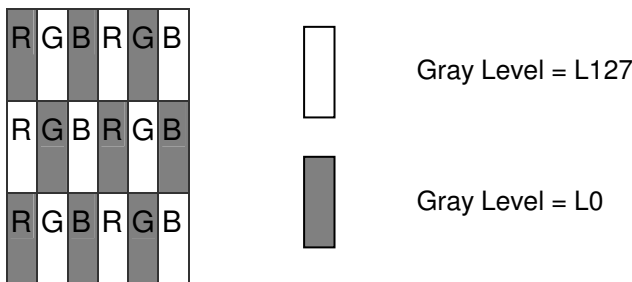

Method: Record dBV & DC value with (WESTAR)TRD-100

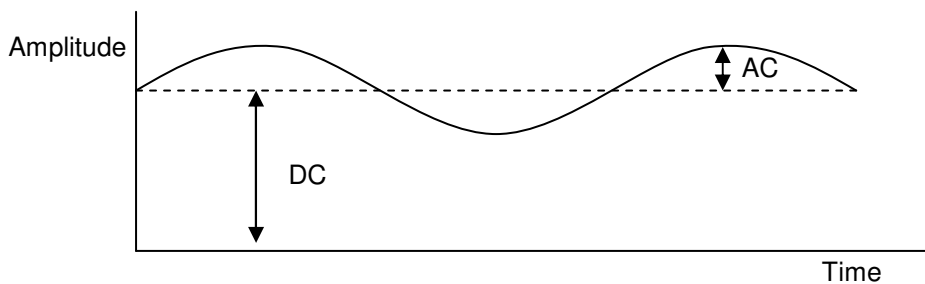

$$\text{Flicker (dB)} = 20 \log \frac{\text{AC Level(at 30 Hz)}}{\text{DC Level}}$$

## 3. Functional Block Diagram

The following diagram shows the functional block of the 19.0 inches Color TFT-LCD Module:

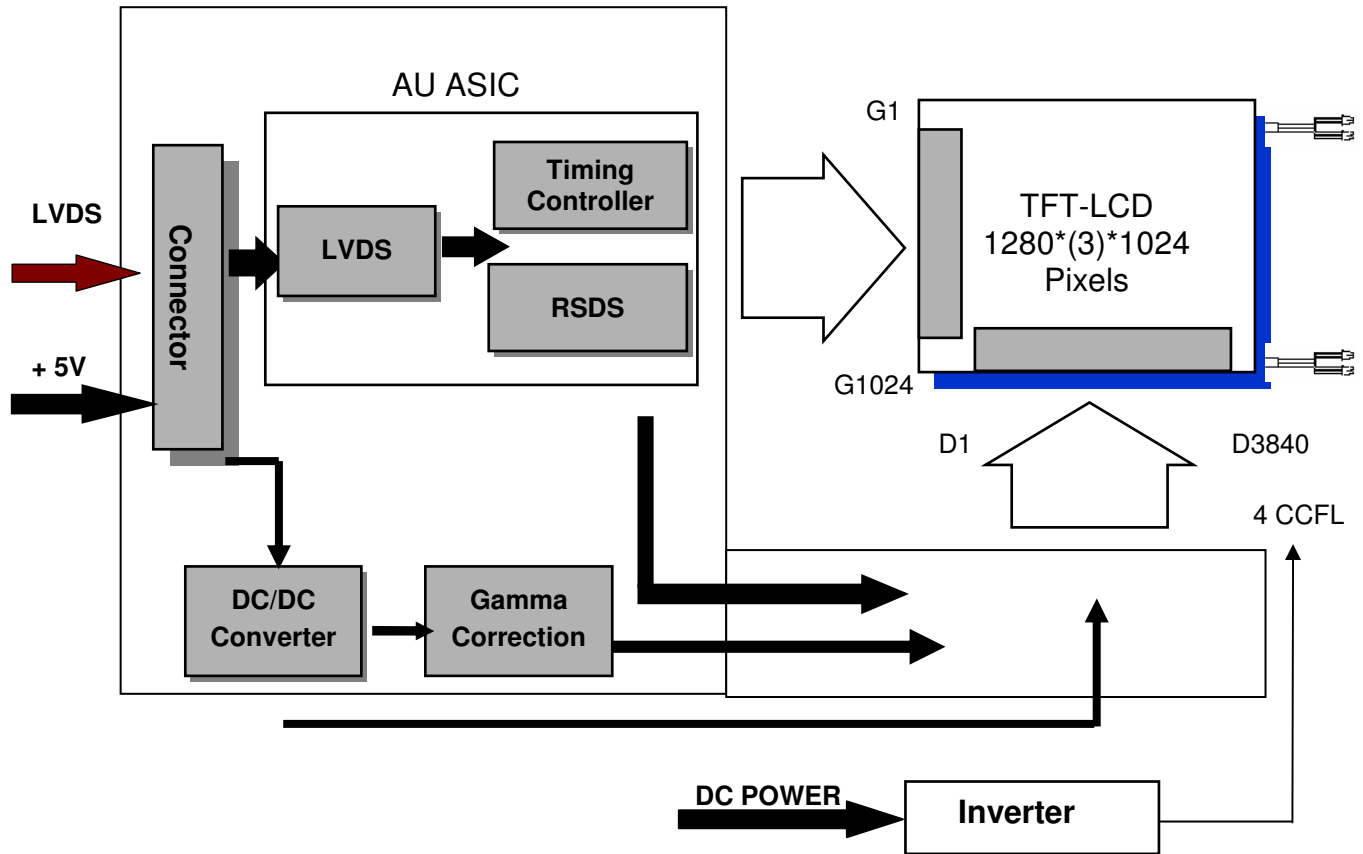

## 4. Absolute Maximum Ratings

Absolute maximum ratings of the module are as following:

### 4.1 Absolute Ratings of TFT LCD Module

Item	Symbol	Min.	Max.	Unit	Conditions
Logic/LCD Drive Voltage	VDD	-0.3	+6	[Volt]	Note 1, 2

### 4.2 Absolute Ratings of Backlight Unit

Item	Symbol	Min.	Max.	Unit	Conditions
CCFL Current	ICFL	-	8	[mA] rms	Note 1, 2

### 4.3 Absolute Ratings of Environment

Item	Symbol	Min.	Max.	Unit	Conditions
Operating Temperature	TOP	0	+50	[°C]	Note 3
Operation Humidity	HOP	5	90	[%RH]	
Storage Temperature	TST	-20	+60	[°C]	
Storage Humidity	HST	5	90	[%RH]	

Note 1: With in  $T_a = 25^\circ\text{C}$

Note 2: Permanent damage to the device may occur if exceed maximum values

Note 3: For quality performance, please refer to AUO IIS (Incoming Inspection Standard).

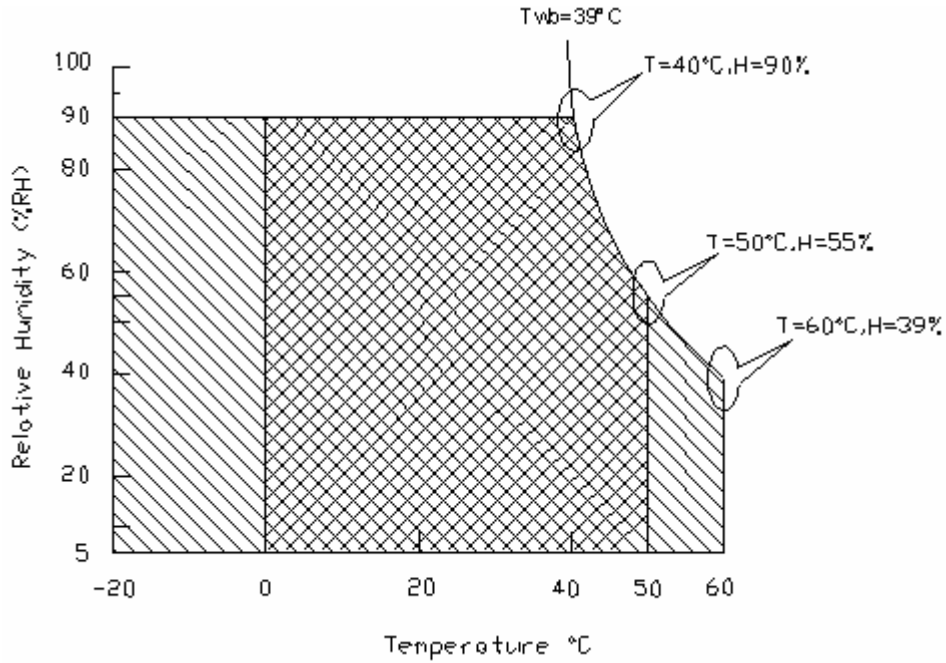

Operating Range



Storage Range

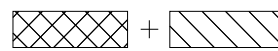

## 5. Electrical characteristics

### 5.1 TFT LCD Module

#### 5.1.1 Power Specification

Input power specifications are as follows:

Symble	Parameter	Min.	Typ.	Max.	Unit	Condition
VDD	Logic/LCD Drive Voltage	4.5	5.0	5.5	[Volt]	±10%
IDD	Input Current	-	1.02	1.34	[A]	VDD= 5.0V, All Black Pattern At 75Hz, +30%
PDD	VDD Power	-	5.11	6.71	[Watt]	VDD= 5.0V, All Black Pattern At 75Hz , Note 1
IRush	Inrush Current	-	-	2.5	[A]	Note 2
VDDrp	Allowable Logic/LCD Drive Ripple Voltage	-	-	100	[mV] p-p	VDD= 5.0V, All Black Pattern At 75Hz

Note 1: The variance of VDD power consumption is ±30%.

Note 2: Measurement conditions:

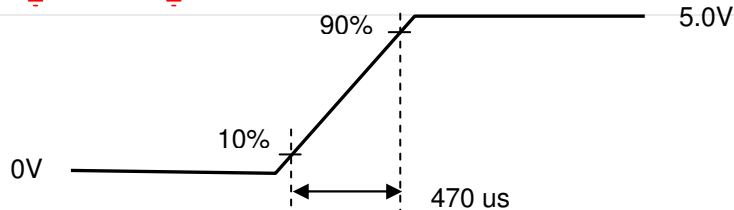
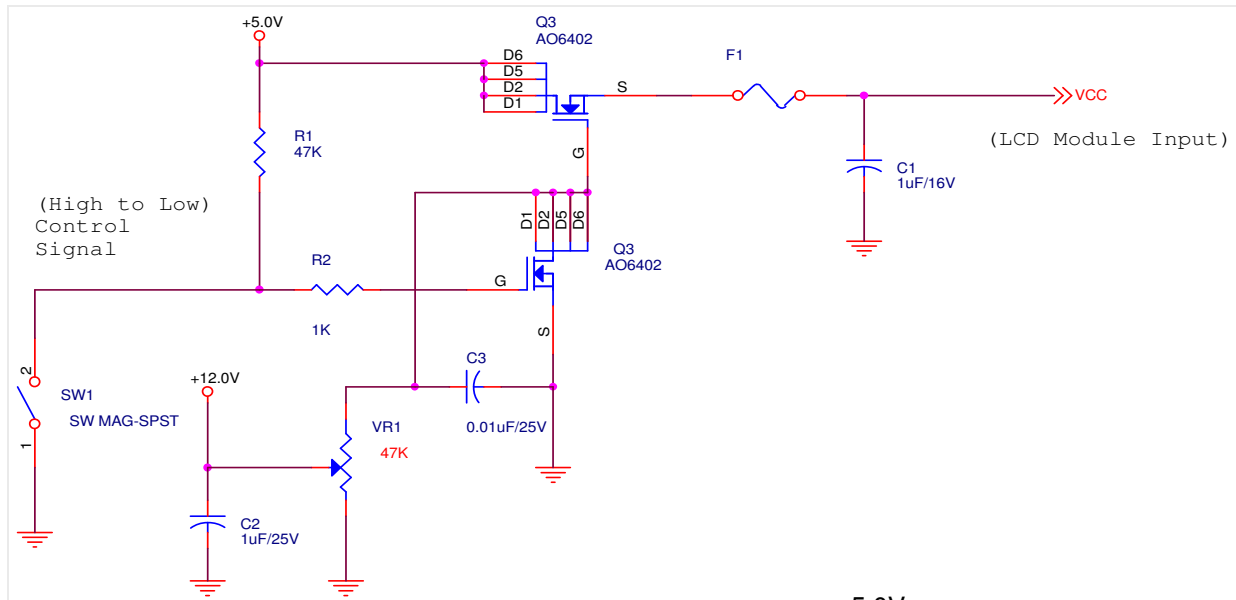

Vin rising time

## 5.2 Backlight Unit

Parameter guideline for CCFL Inverter is under stable conditions at 25□ (Room Temperature):

Parameter	Min.□	Typ.	Max.□	Unit	Condition
CCFL Standard Current(ISCFL)	7.0□	7.5	8.0	[mA] rms	Note 2
CCFL Operation Current(IRCFL)	3.0□	7.5	8.0	[mA] rms	Note 2
CCFL Frequency(FCFL)	40	60	80	[KHz]	Note 3,4
CCFL Ignition Voltage(ViCFL, Ta= 0□)	1690	-	-	[Volt] rms	Note 5
CCFL Ignition Voltage(ViCF, Ta= 25□)	1300	-	-	[Volt] rms	
CCFL Operation Voltage (VCFL)	544 (@ 7.5mA)	653 (@ 7.5mA)	783 (@ 7.5mA)	[Volt] rms	Note 6
CCFL Power Consumption(PCFL)	-	19.6	21.56	[Watt]	Note 6
CCFL Life Time(LTCFL)	40,000	50,000	-	[Hour]	Note 7

Note 1: Typ. are AUO recommended design points.

- \*1 All of characteristics listed are measured under the condition using the AUO test inverter.
- \*2 In case of using an inverter other than listed, it is recommended to check the inverter carefully. Sometimes, interfering noise stripes appear on the screen, and substandard luminance or flicker at low power may happen.
- \*3 In designing an inverter, it is suggested to check safety circuit very carefully. Impedance of CCFL, for instance, becomes more than 1 [M ohm] when CCFL is damaged.
- \*4 Generally, CCFL has some amount of delay time after applying kick-off voltage. It is recommended to keep on applying kick-off voltage for 1 [Sec] until discharge.
- \*5 Reducing CCFL current increases CCFL discharge voltage and generally increases CCFL discharge frequency. So all the parameters of an inverter should be carefully designed so as not to produce too much leakage current from high-voltage output of the inverter.

Note 2: CCFL standard current is measured at 25±2°C.

Note 3: CCFL discharge frequency should be carefully determined to avoid interference between inverter and TFT LCD.

Note 4: The frequency range will not affect to lamp life and reliability characteristics.

Note 5: CCFL inverter should be able to give out a power that has a generating capacity of over 1,690 voltage. Lamp units need 1,690 voltage minimum for ignition.

Note 6: The variance of CCFL power consumption is ±10%. Calculator value for reference (ISCFL × VCFL × 4 = PCFL)

Note 7: Definition of life: brightness becomes 50%. The typical life time of CCFL is on the condition at 7.5 mA lamp current.





## 6.2 The Input Data Format

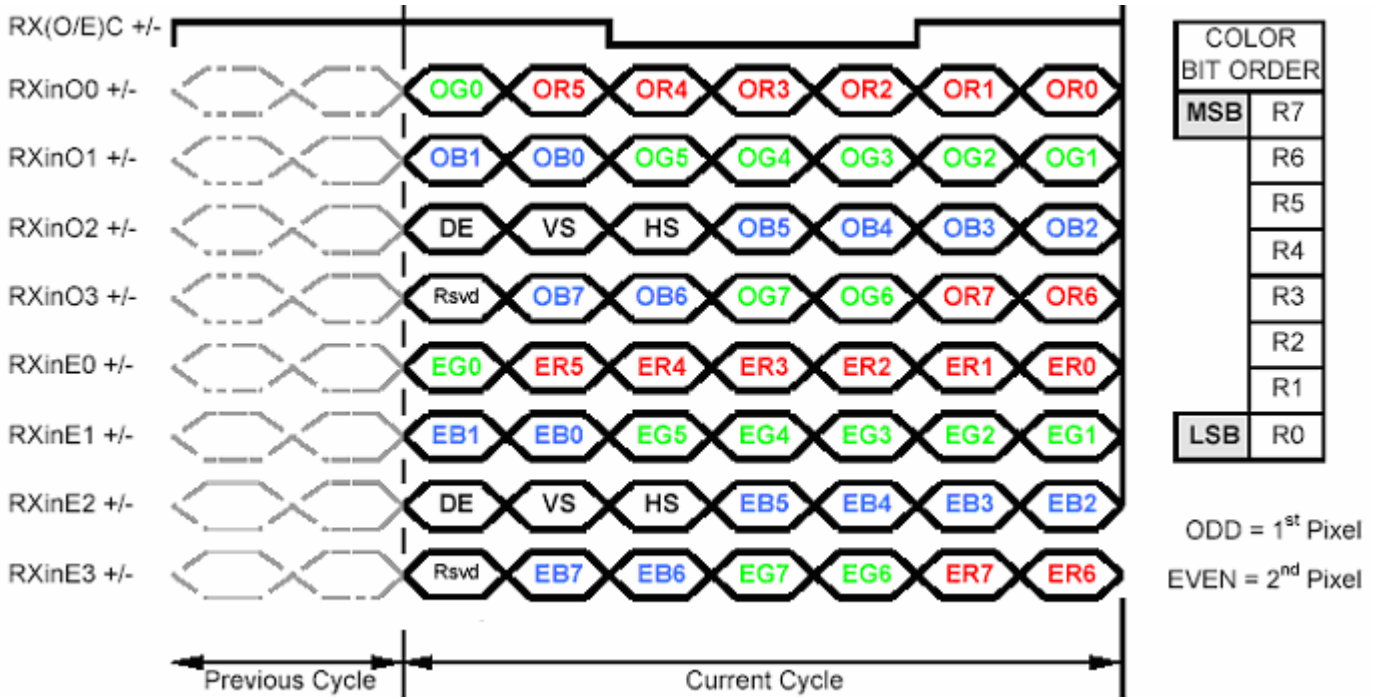

Note1: Normally, DE, VS, HS on EVEN channel are not used.

Note2: Please follow PSWG.

Note3: 8-bit in

## 6.3 Signal Description

The module using a pair of LVDS receiver SN75LVDS82(Texas Instruments) or compatible. LVDS is a differential signal technology for LCD interface and high speed data transfer device. Transmitter shall be SN75LVDS83(negative edge sampling) or compatible. The first LVDS port(RxOxxx) transmits odd pixels while the second LVDS port(RxExxx) transmits even pixels.

PIN #	SIGNAL NAME	DESCRIPTION
1	RxOIN0-	Negative LVDS differential data input (Odd data)
2	RxOIN0+	Positive LVDS differential data input (Odd data)
3	RxOIN1-	Negative LVDS differential data input (Odd data)
4	RxOIN1+	Positive LVDS differential data input (Odd data)
5	RxOIN2-	Negative LVDS differential data input (Odd data, H-Sync,V-Sync,DSPTMG)
6	RxOIN2+	Positive LVDS differential data input (Odd data, H-Sync,V-Sync,DSPTMG)
7	VSS	Power Ground
8	RxOCLKIN-	Negative LVDS differential clock input (Odd clock)
9	RxOCLKIN+	Positive LVDS differential clock input (Odd clock)
10	RxOIN3-	Negative LVDS differential data input (Odd data)
11	RxOIN3+	Positive LVDS differential data input (Odd data)
12	RxEIN0-	Negative LVDS differential data input (Even data)
13	RxEIN0+	Positive LVDS differential data input (Even data)
14	VSS	Power Ground
15	RxEIN1-	Negative LVDS differential data input (Even data)
16	RxEIN1+	Positive LVDS differential data input (Even data)
17	VSS	Power Ground
18	RxEIN2-	Negative LVDS differential data input (Even data)
19	RxEIN2+	Positive LVDS differential data input (Even data)
20	RxECLKIN-	Negative LVDS differential clock input (Even clock)
21	RxECLKIN+	Positive LVDS differential clock input (Even clock)
22	RxEIN3-	Negative LVDS differential data input (Even data)
23	RxEIN3+	Positive LVDS differential data input (Even data)
24	VSS	Power Ground
25	VSS	Power Ground
26	NC	No Connection ( for AUO test)
27	VSS	Power Ground
28	VCC	+5.0V Power Supply
29	VCC	+5.0V Power Supply
30	VCC	+5.0V Power Supply

Note1: Start from left side

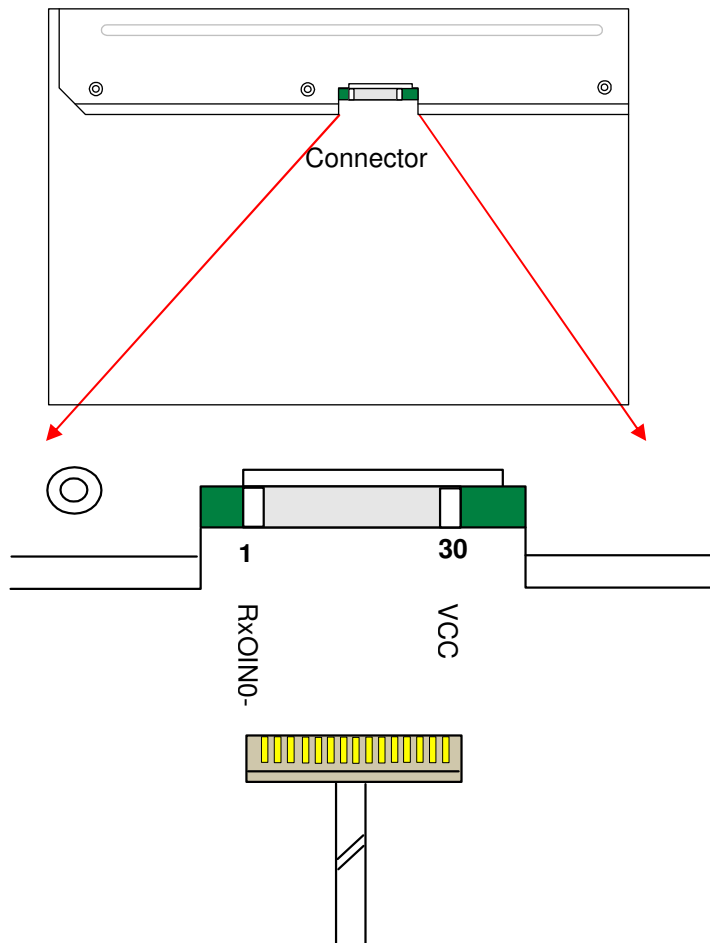

Note2: Input signals of odd and even clock shall be the same timing.

Note3: Please follow PSWG.

## 6.4 Interface Timing

### 6.4.1 Timing Characteristics

Item	Symbol	Min	Typ	Max	Unit
Data CLK	Tclk	40	54	67.5	MHz
H-section	Period	Th	844	1024	Tclk
	Display Area	Tdisp(h)	640	640	640
V-section	Period	Tv	1066	2048	Th
	Display Area	Tdisp(v)	1024	1024	1024
Frame Rate	F	50	60	75	Hz

Note : DE mode only

## 6.4.2 Timing Diagram

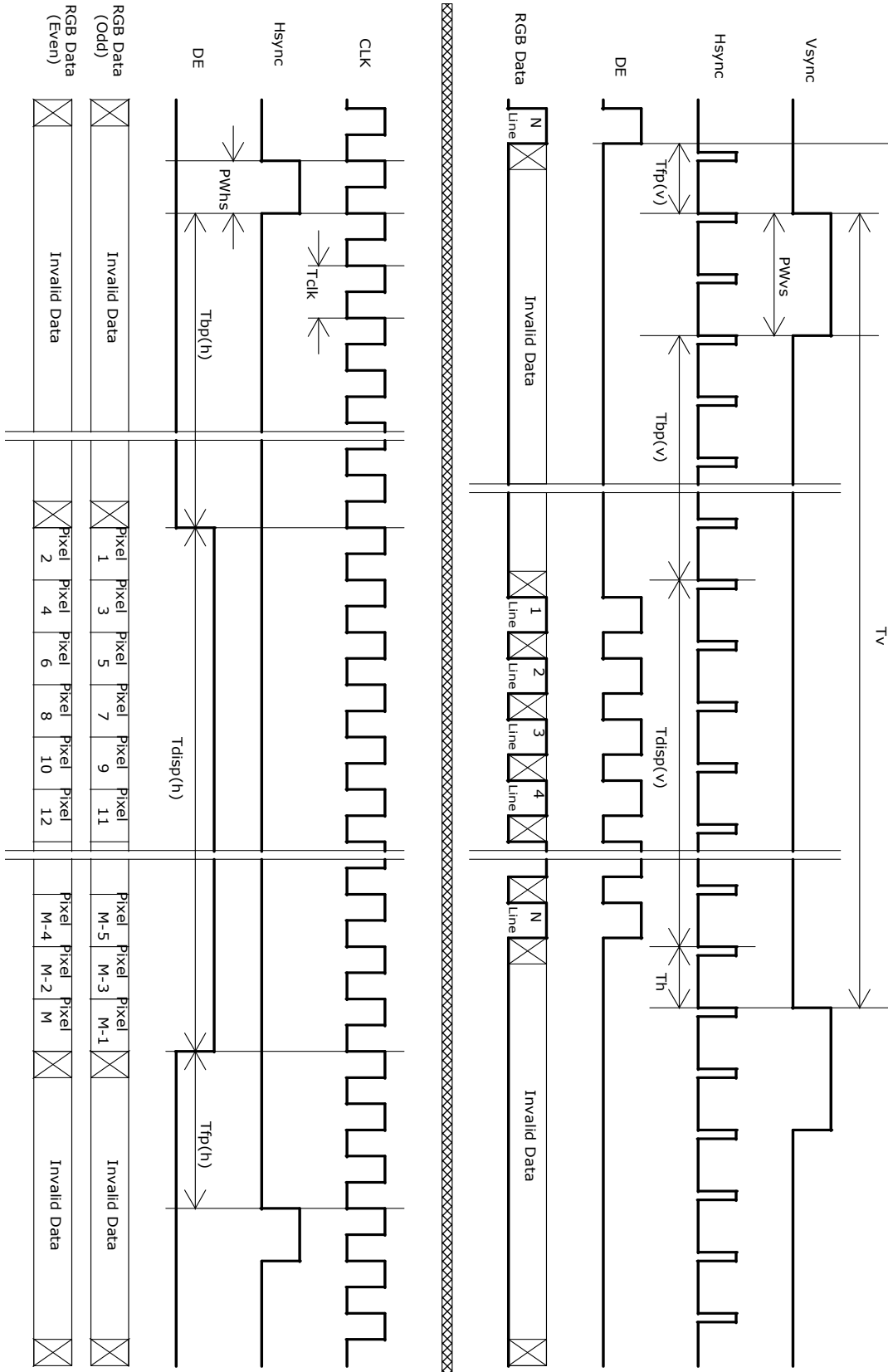

## 6.5 Power ON/OFF Sequence

VDD power and lamp on/off sequence is as follows. Interface signals are also shown in the chart. Signals from any system shall be Hi-Z state or low level when VDD is off.

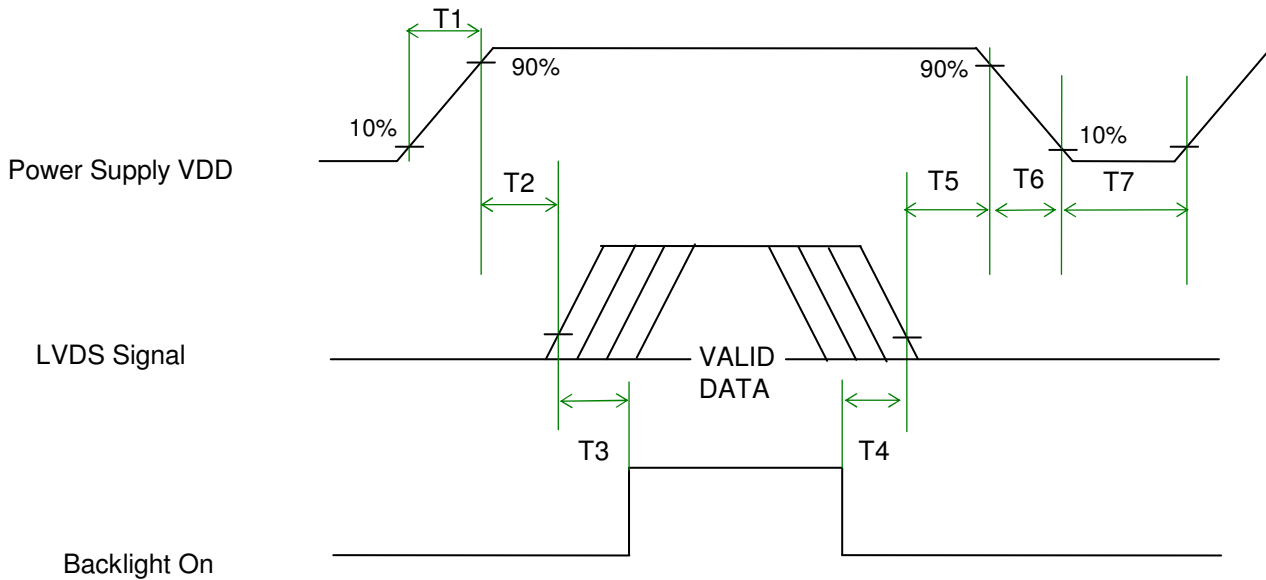

**Power Sequence Timing**

Parameter	Value			Unit
	Min.	Typ.	Max.	
T1	0.5	-	10	[ms]
T2	0	-	50	[ms]
T3	300	-	-	[ms]
T4	300	-	-	[ms]
T5	0	16	50	[ms]
T6	-	-	10	[ms]
T7	500	-	-	[ms]

## 7. Connector & Pin Assignment

Physical interface is described as for the connector on module. These connectors are capable of accommodating the following signals and will be following components.

### 7.1 TFT LCD Module

#### 7.1.1 Connector

Connector Name / Designation	Interface Connector / Interface card
Manufacturer	JAE or compatible
Type Part Number	FI-XB30SSL-HF15
Mating Housing Part Number	FI-X30HL

#### 7.1.2 Pin Assignment

Pin#	Signal Name	Pin#	Signal Name
1	RxOIN0-	2	RxOIN0+
3	RxOIN1-	4	RxOIN1+
5	RxOIN2-	6	RxOIN2+
7	VSS	8	RxOCLKIN-
9	RxOCLKIN+	10	RxOIN3-
11	RxOIN3+	12	RxEIN0-
13	RxEIN0+	14	VSS
15	RxEIN1-	16	RxEIN1+
17	VSS	18	RxEIN2-
19	RxEIN2+	20	RxECLKIN-
21	RxECLKIN+	22	RxEIN3-
23	RxEIN3+	24	VSS
25	VSS	26	NC
27	VSS	28	VCC
29	VCC	30	VCC

## 7.2 Backlight Unit

Physical interface is described as for the connector on module. These connectors are capable of accommodating the following signals and will be following components.

Connector Name / Designation	Lamp Connector / Backlight lamp
Manufacturer	CVILUX or YEONHO
Type Part Number	CP0502SL090/ 35001 HS-02L
Mating Type Part Number	CP0502P1ML0/ 35001 WR-02L

### 7.2.1 Signal for Lamp connector

	Connector No.	Pin No.	Input	Color	Function
Upper	CN1	1	Hot1	Pink	High Voltage
		2	Cold1	White	Low Voltage
	CN2	1	Hot2	Pink	High Voltage
		2	Cold2	White	Low Voltage

	Connector No.	Pin No.	Input	Color	Function
Lower	CN3	1	Hot1	Pink	High Voltage
		2	Cold1	White	Low Voltage
	CN4	1	Hot2	Pink	High Voltage
		2	Cold2	White	Low Voltage

## 8. Reliability Test

Environment test conditions are listed as following table.

Items	Required Condition	Note
Temperature Humidity Bias (THB)	Ta= 50□, 80%RH, 300hours	
High Temperature Operation (HTO)	Ta= 50□, 50%RH, 300hours	
Low Temperature Operation (LTO)	Ta= 0□, 300hours	
High Temperature Storage (HTS)	Ta= 60□, 300hours	
Low Temperature Storage (LTS)	Ta= -20□, 300hours	
Vibration Test (Non-operation)	Acceleration: 1.5 G Wave: Random Frequency: 10 - 200 - 10 Hz Sweep: 30 Minutes each Axis (X, Y, Z)	
Shock Test (Non-operation)	Acceleration: 50 G Wave: Half-sine Active Time: 20 ms Direction: ±X, ±Y, ±Z (one time for each Axis)	
Drop Test	Height: 60 cm, package test	
Thermal Shock Test (TST)	-20□/30min, 60□/30min, 100 cycles	1
On/Off Test	On/10sec, Off/10sec, 30,000 cycles	
ESD (ElectroStatic Discharge)	Contact Discharge: ± 8KV, 150pF(330Ω ) 1sec, 8 points, 25 times/ point.	2
	Air Discharge: ± 15KV, 150pF(330Ω ) 1sec 8 points, 25 times/ point.	
Altitude Test	Operation:10,000 ft Non-Operation:30,000 ft	

Note 1: The TFT-LCD module will not sustain damage after being subjected to 100 cycles of rapid temperature change. A cycle of rapid temperature change consists of varying the temperature from -20°C to 60°C, and back again. Power is not applied during the test. After temperature cycling, the unit is placed in normal room ambient for at least 4 hours before power on.





Note 2: According to EN61000-4-2 , ESD class B: Some performance degradation allowed. No data lost. Self-recoverable. No hardware failures.





### 9. Shipping Label

The shipping label format is shown as below.

 *XXXXXXXXXXXX-XXXXX*	Manufactured XX/XX Model No: M190EG02 AU Optronics MADE IN XXXXXX (XX)	V.4 XXXXX	 E204356	
 XXXXXXXXXXXXXXXXXXXX				



# Product Specification

M190EG02 V4

AU OPTRONICS CORPORATION

## 10. Mechanical Characteristic

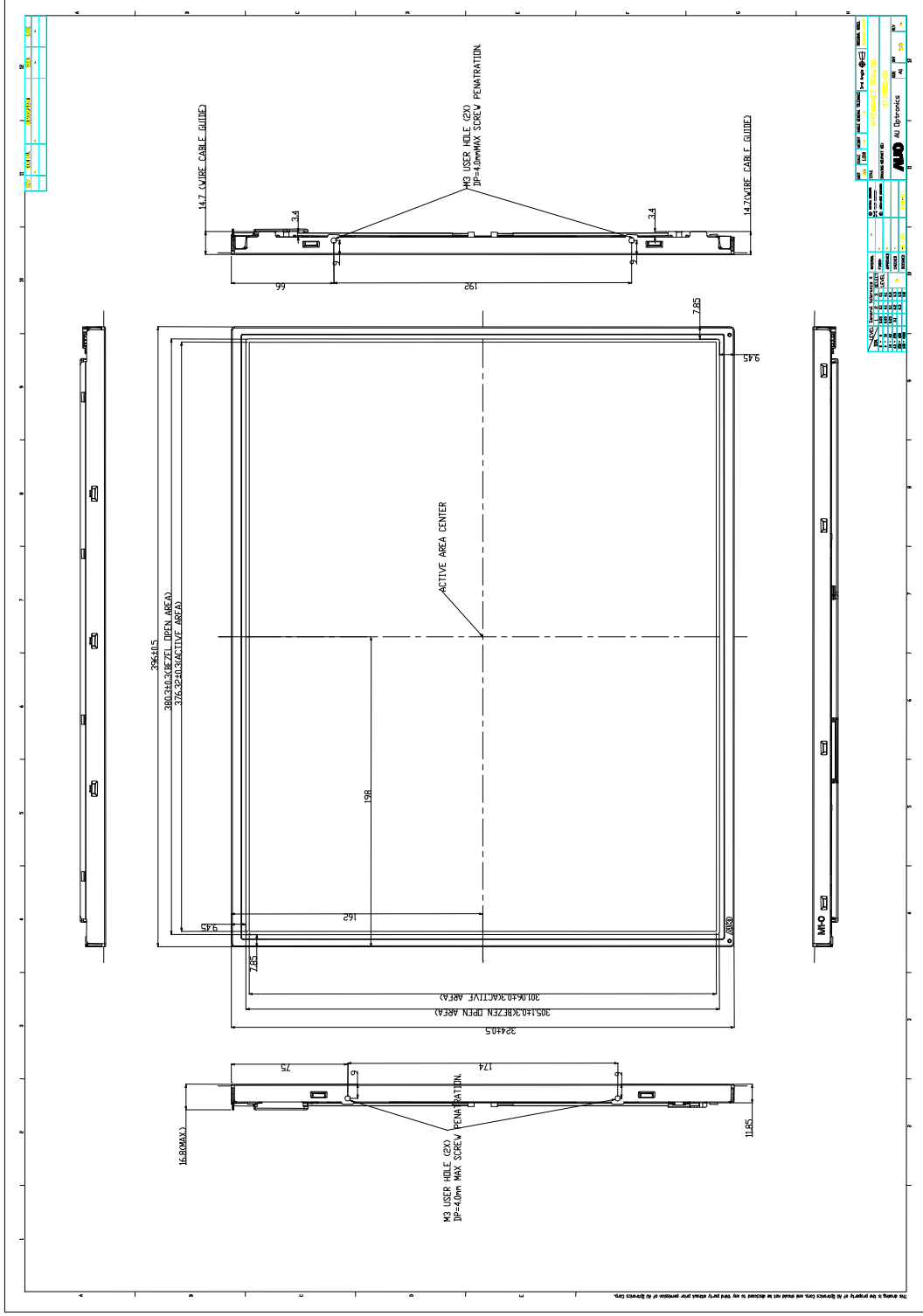



# Product Specification

AU OPTRONICS CORPORATION

M190EG02 V4

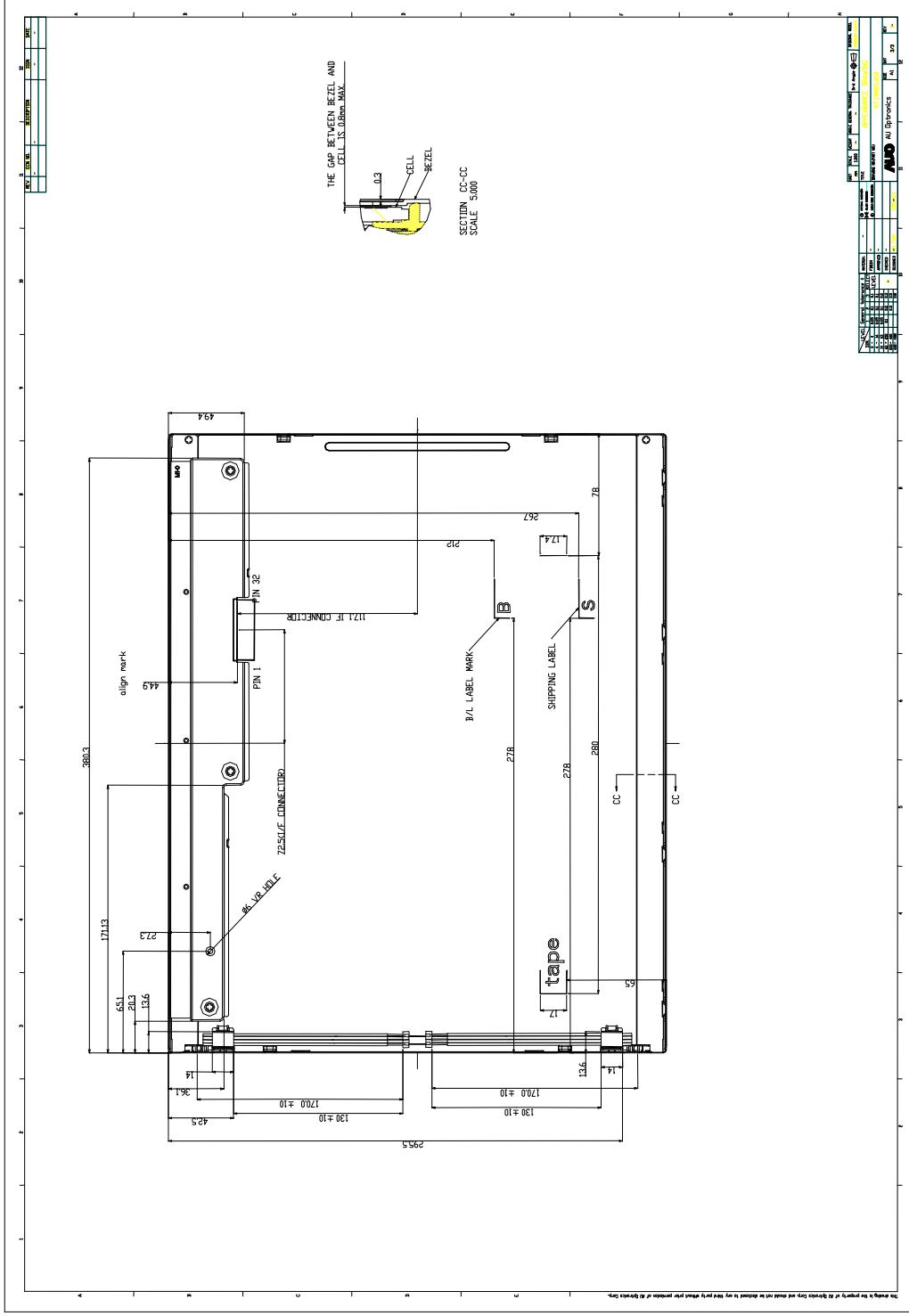



# Product Specification

AU OPTRONICS CORPORATION

M190EG02 V4

